

**Title: Upadacitinib for Psoriatic Arthritis Refractory to Biologics: SELECT-PsA 2**

**Authors:** Philip Mease, M.D.<sup>1</sup>, Apinya Lertratanakul, M.D.<sup>2</sup>, Jaclyn K Anderson, D.O.<sup>2</sup>, Kim Papp, M.D.<sup>3</sup>, Filip van den Bosch, M.D. Ph.D.<sup>4</sup>, Shigeyoshi Tsuji, M.D.<sup>5</sup>, Eva Dokoupilova, M.D.<sup>6</sup>, Mauro Keiserman, M.D.<sup>7</sup>, Xin Wang, Ph.D.<sup>2</sup>, Sheng Zhong, Ph.D.<sup>2</sup>, Reva M Mccaskill, M.D.<sup>6</sup>, Patrick Zueger, PharmD Ph.D.<sup>2</sup>, Aileen L. Pangan, M.D.<sup>2</sup>, William Tillett, M.D. Ph.D.<sup>8</sup>

**Affiliations:**

<sup>1</sup>Department of Rheumatology, Swedish Medical Center/Providence St. Joseph Health and University of Washington, Seattle, Washington, USA

<sup>2</sup>AbbVie Inc., North Chicago, Illinois, USA

<sup>3</sup>Papp Clinical Research and Probitry Medical Research, Waterloo, ON, Canada

<sup>4</sup>Department of Internal Medicine and Pediatrics, Ghent University, VIB Center for Inflammation Research, Ghent, Belgium

<sup>5</sup>Department of Orthopaedics/Rheumatology, National Hospital Organization, Osaka Minami Medical Center, Osaka, Japan

<sup>6</sup>Medical Plus, Uherske Hradiste, Czech Republic, and University of Veterinary and Pharmaceutical Sciences, Brno, Czech Republic

<sup>7</sup>Pontifical Catholic University, School of Medicine, Porto Alegre, Brazil

<sup>8</sup> Royal National Hospital for Rheumatic Diseases and University of Bath, Pharmacy and Pharmacology, Bath, United Kingdom

**Corresponding author:**

Dr. Philip Mease  
Seattle Rheumatology Associates  
601 Broadway, Seattle, WA 98122  
Email: [pmease@philipmease.com](mailto:pmease@philipmease.com)  
Telephone number: (206) 386-2000

**Funding:** AbbVie Inc.

## Table of Contents

<b>Section 1.</b> List of trial investigators.....	3
<b>Section 2.</b> Inclusion and Exclusion Criteria .....	5
<b>Figure S1.</b> Trial design of SELECT-PsA 2 .....	12
<b>Figure S2.</b> Graphical Multiple Testing Procedure to Assigning Statistical Significance for the Primary and Ranked Secondary Endpoints.....	13
<b>Figure S3.</b> Patient Disposition at Week 24 .....	14
<b>Figure S4.</b> Forest Plot of ACR20 at Week 12 by (A) Demographic Subgroups; (B) Baseline Disease Characteristic Subgroups .....	15
<b>Figure S5.</b> Change from Baseline Over 24 Weeks in Core Components of the ACR Criteria (A) TJC68 (B) SJC66 (C) PhGA (D) PtGA (E) Pain (F) hs-CRP .....	18
<b>Figure S6.</b> Proportions of Patients Achieving sIGA 0/1 Over 24 Weeks .....	20
<b>Figure S7.</b> Change from Baseline Over 24 Weeks in SAPS .....	21
<b>Figure S8.</b> Change from Baseline Over 24 Weeks in (A) HAQ-DI and (B) SF-36 Physical Component Summary .....	22
<b>Figure S9.</b> Change from Baseline Over 24 Weeks in FACIT-F .....	23
<b>Figure S10.</b> (A) Change from Baseline Over 24 Weeks in Morning Stiffness (Mean of BASDAI Questions 5 and 6), (B), Morning Stiffness Severity (BASDAI Question 5), (C) Morning Stiffness Duration (BASDAI Question 6) .....	24
<b>Figure S11.</b> Proportion of Patients with Resolution of Enthesitis Over 24 Weeks (A) by LEI and (B) by SPARCC; (C) Proportion of Patients with Resolution of Dactylitis by LDI.....	25
<b>Figure S12.</b> (A) Mean values from Baseline Over 24 Weeks (A) Hemoglobin (B) Platelets (C) Neutrophils (D) Lymphocytes .....	26
<b>Figure S13.</b> Mean Values from Baseline Over 24 Weeks (A) LDL-C and (B) HDL-C; Mean ratio (C) LDL-C:HDL-C and (D) Total Cholesterol:HDL-C .....	27
<b>Table S1.</b> Description of Efficacy Measures.....	28

<b>Table S2.</b> Power of Key Secondary Endpoints .....	30
<b>Table S3.</b> Patients with Treatment-Emergent Adverse Events Reported in $\geq 5\%$ of Patients in any Treatment Arm up to Week 24 (Safety Analysis Set).....	31
<b>Table S4.</b> Patients Meeting Criteria for Potentially Clinically Significant Values for Laboratory Variables up to Week 24 .....	32
<b>Table S5.</b> Shift Analysis for the Lipids from Within Normal Limit to Upper Limit Normal .....	33
<b>References</b> .....	34

**Section 1. List of trial investigators**

**Belgium:** Dr. Johan Vanhoof, Prof. Filip Van den Bosch

**Brazil:** Dr. Rodrigo Assad, Dr. Claudia Goldenstein-Schainberg, Prof. Mauro Keiserman, Dr. Sonia Maria Alvarenga Anti Loduca Lima, Dr. Roberto Ranza, Prof. Ricardo Xavier, Dr. Antonio Ximenes

**Canada:** Dr. David Shaw, Dr. Louis Bessette, Dr. Derek Haaland, Dr. Glen Thomson, Dr. Clode Lessard

**Chile:** Dr. Lilian Soto, Dr. Maria Francisca Bozan, Dr. Ivan Gonzalez, Dr. Irmgardt Annelise Goecke Sariego

**Czech Republic:** Dr. Eva Dokoupilova, Dr. Dagmar Galatikova

**France:** Prof. Alain Cantagrel, Prof. Philippe Goupille, Prof. Pascal Richette

**Greece:** Dr. Gkikas Katsifis, Prof. Athanasios Tzioufas

**Hungary:** Dr. Edit Drescher, Dr. Janos Gaal, Dr. Marta Megyaszi, Dr. Attila Kovacs, Dr. Bernadette Rojkovich

**Italy:** Dr. Armando Gabrielli, Dr. Rosario Foti, Dr. Antonio Marchesoni

**Japan:** Dr. Shinichi Imafuku, Dr. Akimichi Morita, Dr. Yoshio Ozaki, Dr. Chiharu Tateishi, Dr. Keiichi Yamanaka, Dr. Mari Higashiyama, Dr. Shigeyoshi Tsuji, Dr. Yoichiro Haji, Dr. Hiroaki Nishizaka, Dr. Motohiro Oribe, Dr. Naoto Tamura, Dr. Hiromichi Tamaki, Dr. Kenshi Yamasaki, Dr. Yuko Kaneko, Mr. Kensaku Okamoto

**Netherlands:** Dr. Marijn Vis

**New Zealand:** Dr. Douglas White, Dr. Sunil Kumar, Dr. Daniel Ching, Dr. David Porter

**Portugal:** Dr. Jose Vaz Pato, Dr. Patricia Pinto, Dr. Elsa Sousa, Dr. Jose Costa

**Puerto Rico:** Dr. Karina Vila-Rivera, Dr. Ramon Toro-Torres

**Spain:** Dr. Francisco Blanco, Dr. Maria Dolores Lopez Montilla

**United Kingdom:** Dr. Simon Donnelly

**United States:** Dr. Alan Kivitz, Dr. Arthur Snyder, Dr. Herbert Baraf, Dr. Christine Coddling, Dr. H.S.

Eugene Fung, Dr. Ramesh Gupta, Dr. Emily Herron Box, Dr. Arthur Mabaquiao, Dr. Chandrakant Mehta,

Dr. Atul Singhal, Dr. David TRUE, Dr. Sanford Wolfe, Dr. Christopher Antolini, Dr. Roshan Kotha, Dr. Eric Lee, Dr. Philip Mease, Dr. Samy Metyas, Dr. Shirley Pang, Dr. Tien-I Su, Dr. Christine Thai, Dr. Michael Burnette, Dr. Michael Kohen, Dr. Robert Levin, Dr. David Sikes, Dr. Farrukh Zaidi, Dr. Charles Birbara, Dr. Ronald George, Dr. Eyal Kedar, Dr. Manish Jain, Dr. Shaikh Arif Ali, Dr. John Carter, Dr. Erdal Diri, Dr. Colin Edgerton, Dr. Roy Fleischmann, Dr. Jose Garcia, Dr. Norman Gaylis, Dr. Julio Gonzalez-Paoli, Dr. Leslie Alan Goodman, Dr. Elias Halpert, Dr. Edgard Janer, Dr. Jeffrey Kaine, Dr. Swati Kumar, Dr. Deepak Kumar, Dr. Jyothi Mallepalli, Dr. William Palmer, Dr. Eric Peters, Dr. Paul Pickrell, Dr. Adriana Pop-Moody, Dr. Roel Querubin, Dr. Joy Schechtman, Dr. Areena Swarup, Dr. Philip Waller, Dr. Karen Zagar, Dr. Brian Kirby, Dr. Yong Tsai, Dr. Rajat Dhar, Dr. Ira Fenton, Dr. Marcin Gornisiewicz, Dr. Robert Hozman, Dr. Mark Genovese, Dr. Aixa Toledo-Garcia

## Section 2. Inclusion and Exclusion Criteria

### Inclusion Criteria

1. Adult male or female, at least  $\geq 18$  years old at Screening.
2. Clinical diagnosis of PsA with symptom onset at least 6 months prior to the Screening Visit and fulfillment of the Classification Criteria for PsA (CASPAR).
3. Subject has active disease at Baseline defined as  $\geq 3$  tender joints (based on 68 joint counts) and  $\geq 3$  swollen joints (based on 66 joint counts) at Screening and Baseline Visits.
4. Diagnosis of active plaque psoriasis or documented history of plaque psoriasis.
5. Subject has had an inadequate response (lack of efficacy after a minimum 12 week duration of therapy) or intolerance to treatment with at least 1 bDMARD.
6. Subjects must have discontinued all bDMARDs prior to the first dose of trial drug. Subjects who need to discontinue bDMARDs prior to the Baseline Visit to comply with this inclusion criterion must follow the procedure specified below or at least five times the mean terminal elimination half-life of a drug:
  - $\geq 4$  weeks for etanercept;
  - $\geq 8$  weeks for adalimumab, infliximab, certolizumab, golimumab, abatacept, tocilizumab, and ixekizumab;
  - $\geq 20$  weeks for secukinumab and ustekinumab.
  - $\geq 1$  year for rituximab OR  $\geq 6$  months if B cells have returned to pretreatment level or normal reference range (local lab) if pretreatment levels are not available.
7. Subject who is on current treatment with concomitant non-biologic DMARDs at trial entry must be on  $\leq 2$  non-biologic DMARDs (except the combination of MTX and leflunomide) at the following doses: MTX ( $\leq 25$  mg/week), SSZ ( $\leq 3000$  mg/day), leflunomide (LEF) ( $\leq 20$  mg/day), apremilast ( $\leq 60$  mg/day), HCQ ( $\leq 400$  mg/day), bucillamine ( $\leq 300$  mg/day) and iguratimod ( $\leq 50$  mg/day) for  $\geq 12$  weeks and at stable dose for  $\geq 4$  weeks prior to the Baseline Visit. No other DMARDs are permitted during the trial.

- Subjects who need to discontinue DMARDs prior to the Baseline Visit to comply with this inclusion criterion must follow the procedure specified below or at least five times the mean terminal elimination half-life of a drug:

- $\geq 8$  weeks for LEF if no elimination procedure was followed, or adhere to an elimination procedure (i.e., 11 days with cholestyramine, or 30 days washout with activated charcoal or as per local label);
- $\geq 4$  weeks for all others.

8. Stable doses of NSAIDs, acetaminophen/paracetamol, low potency opiates (tramadol or combination of acetaminophen and codeine or hydrocodone), oral corticosteroids (equivalent to prednisone  $\leq 10$  mg/day), or inhaled corticosteroids for stable medical conditions are allowed, but must have been at a stable dose for  $\geq 1$  weeks prior to the Baseline Visit.

9. Subjects must have discontinued all opiates (except for tramadol or combination of acetaminophen and codeine or hydrocodone) at least 1 week and oral Traditional Chinese Medicine for at least 4 weeks prior to the first dose of trial drug.

10. Women of childbearing potential, must not have a positive serum pregnancy test at the Screening Visit and must have a negative urine pregnancy test at the Baseline Visit prior to trial drug dosing.

Note: Subjects with a borderline serum pregnancy test at Screening must have a serum pregnancy test  $\geq 3$  days later to document continued lack of a positive result.

11. If female, subject must be postmenopausal OR permanently surgically sterile OR for Women of Childbearing Potential practicing at least one protocol specified method of birth control, that is effective from the Baseline Visit through at least 30 days after the last dose of trial drug.

- Additional local requirements may apply.

If male and subject is sexually active with a female partner(s) of childbearing potential, he must practice the protocol specified contraception from the Baseline Visit through at least 30 days after last dose of trial drug.

- Additional local requirements may apply.

12. Subjects must voluntarily sign and date an informed consent, approved by an Independent Ethics Committee (IEC)/Institutional Review Board (IRB), prior to the initiation of any screening or trial-specific procedures. For subjects in Japan only: if a subject is under 20 years of age, then the subject and their parent or legal guardian must voluntarily sign and date an informed consent.



### Exclusion Criteria

1. Prior exposure to any Janus Kinase (JAK) inhibitor (including but not limited to ruxolitinib, tofacitinib, baricitinib, and filgotinib).
2. Current treatment with > 2 non-biologic DMARDs or use of DMARDs other than MTX, SSZ, LEF, apremilast, HCQ, bucillamine or iguratimod or use of MTX in combination with LEF at Baseline.
3. Has been treated with any investigational drug within 30 days or five half-lives of the drug (whichever is longer) prior to the first dose of trial drug or is currently enrolled in another clinical trial.
4. Current or past history of infection including:
  - History of recurrent or disseminated (even a single episode) herpes zoster;
  - History of disseminated (even a single episode) herpes simplex;
  - History of known invasive infection (e.g., listeriosis and histoplasmosis);
  - Active human immunodeficiency virus (HIV) or immunodeficiency syndrome. Active HIV is defined as confirmed positive anti-HIV antibody (HIV Ab) test;
  - Subject has active TB or meets TB exclusionary parameters
  - For subjects in Japan only: Positive result of beta-D-glucan (screening for pneumocystis jiroveci infection);
  - Active infection(s) requiring treatment with parenteral anti-infectives within 30 days, or oral anti-infectives within 14 days prior to the Baseline Visit;
  - Chronic recurring infection and/or active viral infection that based on the investigator's clinical assessment makes the subject an unsuitable candidate for the trial;
  - Active HBV or HCV defined as:
    - HBV: hepatitis B surface antigen (HBs Ag) positive (+) or detected sensitivity on the HB deoxyribonucleic acid (DNA) polymerase chain reaction (PCR) qualitative test for hepatitis B core antibody (HBc Ab) positive (+) subjects (and for Hepatitis B surface antibody positive [+] subjects in Japan or where mandated by local requirements);

- HCV: HCV ribonucleic acid (RNA) detectable in any subject with anti-HCV antibody (HCV Ab).

5. Underlying medical diseases or problems including but not limited to the following:

- History of any of the following cardiovascular conditions:
  - Recent (within past 6 months) cerebrovascular accident, myocardial infarction, coronary stenting;
  - Uncontrolled hypertension as defined by a confirmed systolic blood pressure > 160 mmHg or diastolic blood pressure > 100 mmHg.
- Subject has been a previous recipient of an organ transplant requiring systemic immunosuppressive therapy;
- History of gastrointestinal perforation (other than appendicitis or penetrating injury), diverticulitis, or significantly increased risk for GI perforation per investigator judgment;
- Conditions that could interfere with drug absorption including but not limited to short bowel syndrome;
- History of any malignancy except for successfully treated NMSC or localized carcinoma in situ of the cervix;
- History of clinically significant medical conditions or any other reason which in the opinion of the investigator would interfere with the subject's participation in this trial or would make the subject an unsuitable candidate to receive trial drug or would put the subject at risk by participating in the protocol; or permanently wheelchair-bound or bedridden or very poor functional status which prevents the ability to perform self-care.

6. Use of the following prohibited concomitant psoriasis treatments within the specified timeframe prior to Baseline:

- Oral retinoids within 4 weeks of the Baseline Visit;
- Psoralens and Ultraviolet A (PUVA) within 4 weeks of the Baseline Visit;
- Ultraviolet A (UVA) or Ultraviolet B (UVB) within 2 weeks of the Baseline Visit;

- Topical treatments (except low potency (Class VI or Class VII) topical corticosteroids on the palms, soles, face, inframammary area, and groin only) within 2 weeks of the Baseline, with the exception of the following:

- Shampoos that contain no corticosteroid
- Bland (without beta or alpha hydroxy acids) emollients
- Low potency (Class VI or VII) topical corticosteroids on the palms, soles, face, inframammary area and groin only.

7. Systemic use of known strong cytochrome P450 (CYP) 3A inhibitors or strong CYP3A inducers from Screening through the last dose of the trial drug.

8. Receipt of any live vaccine within 4 weeks (8 weeks in Japan) prior to the Baseline Visit, or expected need of live vaccination during trial participation including a least 4 weeks (8 weeks in Japan) after the last dose of trial drug.

9. Subject has received oral or parenteral Traditional Chinese Medicines within weeks prior to Baseline.

10. History of an allergic reaction or significant sensitivity to constituents of the trial drugs (or its excipients) and/or other products in the same class.

11. History of any fibromyalgia, any arthritis with onset prior to age 17 years, or diagnosis of inflammatory joint disease other than PsA (including, but not limited to rheumatoid arthritis, gout, overlap connective tissue diseases, scleroderma, polymyositis, dermatomyositis, systemic lupus erythematosus). Prior history of reactive arthritis or axial spondyloarthritis including ankylosing spondylitis and non-radiographic axial spondyloarthritis is permitted if documentation of change in diagnosis to PsA or additional diagnosis of PsA is made. Prior history of fibromyalgia is permitted if documentation of change in diagnosis to PsA or documentation that the diagnosis of fibromyalgia was made incorrectly.

12. History of clinically significant (per Investigator's judgment) drug or alcohol abuse within the last 6 months preceding the Baseline Visit.

13. Female subject who is pregnant, breastfeeding or is considering becoming pregnant during the trial or for approximately 30 days after the last dose of trial drug.

14. Male subject who is considering fathering a child or donating sperm during the trial or for approximately 30 days after the last dose of trial drug.

15. Laboratory values meeting the following criteria within the Screening period:

- Serum aspartate transaminase (AST)  $> 2 \times$  ULN;
- Serum alanine transaminase (ALT)  $> 2 \times$  ULN;
- Estimated glomerular filtration rate (GFR) by simplified 4-variable

Modification of Diet in Renal Disease (MDRD) formula  $< 40$  mL/min/1.73m<sup>2</sup>;

- Total white blood cell count (WBC)  $< 2,500/\mu\text{L}$ ;
- Absolute neutrophil count (ANC)  $< 1,500/\mu\text{L}$ ;
- Platelet count  $< 100,000/\mu\text{L}$ ;
- Absolute lymphocyte count  $< 800/\mu\text{L}$ ;
- Hemoglobin  $< 10$  g/dL.

16. Active skin disease other than psoriasis that would interfere with the assessment of psoriasis.

17. Subject with extra-articular manifestations of PsA (e.g., PsO, uveitis, or IBD) that are not clinically stable for at least 30 days prior to trial entry.

18. Subject has had joint surgery at joints to be assessed within this trial or has been treated with intra-articular, intramuscular, intravenous, trigger point or tender point, intra-bursa, or intra-tendon sheath corticosteroids in the preceding 8 weeks prior to the Baseline Visit.

19. Consideration by the Investigator, for any reason, that the subject is an unsuitable candidate to receive upadacitinib.

**Figure S1. Trial design of SELECT-PsA 2**

ACR20, American College of Rheumatology 20% improvement criteria; DMARD, disease-modifying anti-rheumatic drugs; OLE, open label extension; PsA, psoriatic arthritis; QD, once daily; SJC, swollen joint count; TJC, tender joint count; UPA, upadacitinib.

Starting at week 16, patients who did not achieve  $\geq 20\%$  improvement in tender and swollen joint counts compared to baseline at weeks 12 and 16 had background medication(s) adjusted or initiated. Starting at week 36, patients who did not achieve  $\geq 20\%$  improvement in tender and swollen joint counts compared to baseline at 2 consecutive visits were discontinued from the study. All patients who complete week 56 were eligible to remain in the extension period of the trial for up to 3 years of trial participation in total. At week 24, all patients allocated to placebo at baseline were switched to blinded once daily upadacitinib 15mg QD or 30mg QD regardless of clinical response.

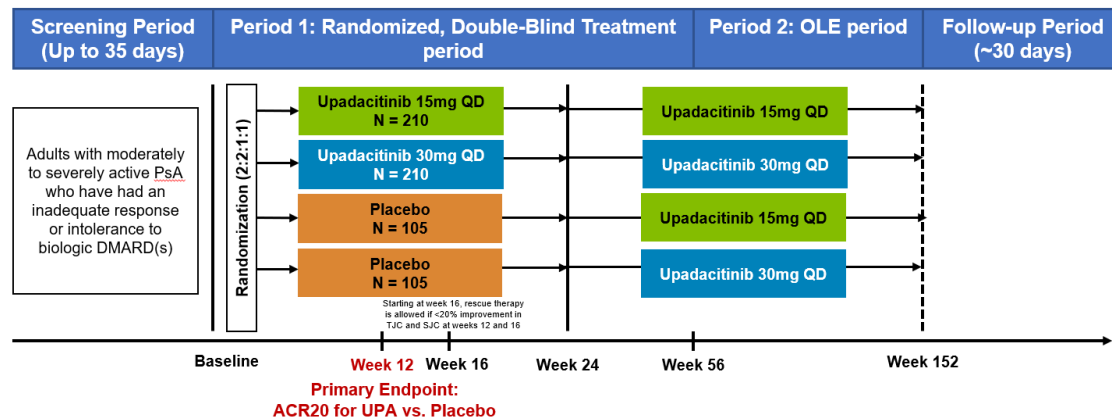

**Figure S2. Graphical Multiple Testing Procedure to Assigning Statistical Significance for the Primary and Ranked Secondary Endpoints**

ACR20, American College of Rheumatology 20% improvement criteria; FACIT-F, Functional Assessment of Chronic Illness Therapy-Fatigue, HAQ-DI, Health Assessment Questionnaire – Disability Index; MDA, minimal disease activity; PASI, Psoriasis Area Severity Index; SAPS, Self-Assessment of Psoriasis Symptoms; SF-36 PCS, 36-Item Short Form Health Survey Physical Component Summary; sIGA, Static Investigator Global Assessment of Psoriasis; Wk, week.

In the figure, the arrows specify the  $\alpha$  transfer paths. Once an endpoint is rejected (i.e., deemed significant) at its assigned significance level, its significance level will be transferred to subsequent endpoint(s) following the arrow(s). The numbers on the arrows denote the weights for transferring significance levels. Specifically, the weight 1 denotes 100% transfer of significance level.

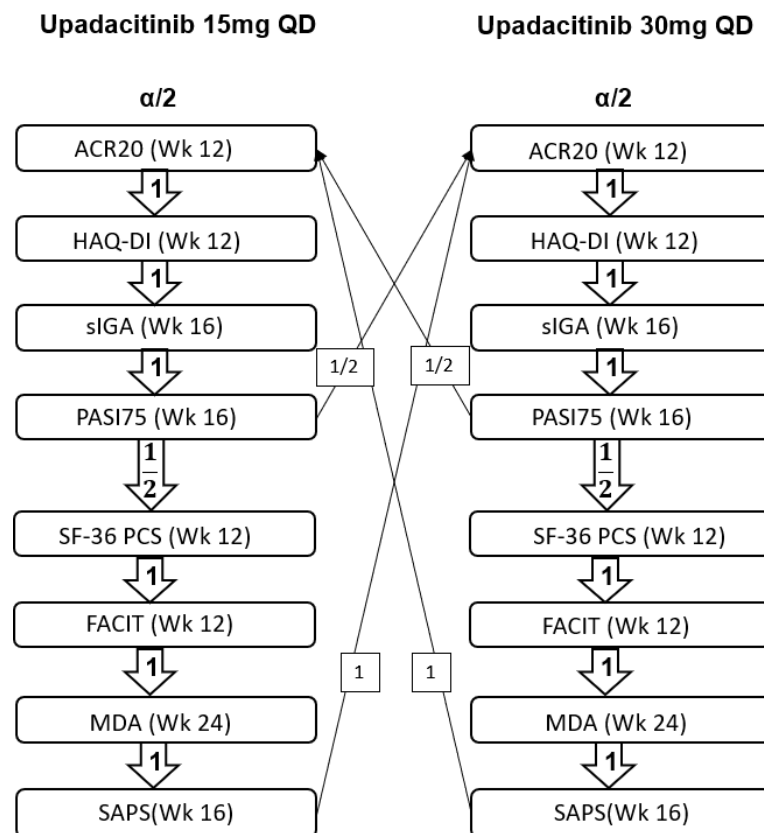

**Figure S3. Patient Disposition at Week 24**

AE, adverse event; QD, once daily; UPA, upadacitinib.

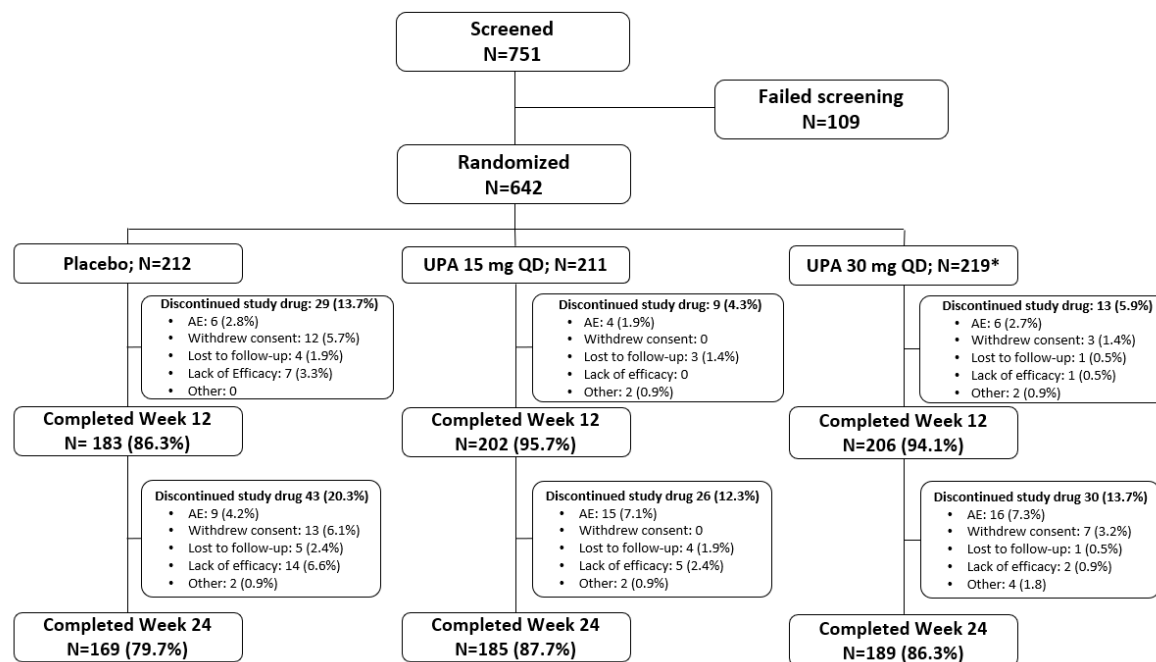

\*1 patient did not receive study drug.  
Numbers reflect completion on study drug.

**Figure S4. Forest Plot of ACR20 at Week 12 by (A) Demographic Subgroups; (B) Baseline Disease Characteristic Subgroups**

ACR20, American College of Rheumatology 20% improvement criteria; bDMARD, biologic disease-modifying anti-rheumatic drug; BMI, body mass index; CI, confidence interval; hs-CRP, high-sensitivity C-reactive protein; PBO, placebo; QD, once daily; PsA, psoriatic arthritis; ULN, upper limit normal; UPA, upadacitinib.

Results are based on non-responder imputation. 95% CIs for response rate were calculated based on normal approximation to the binominal distribution. 95% CIs for response rate difference were calculated based on normal approximation.



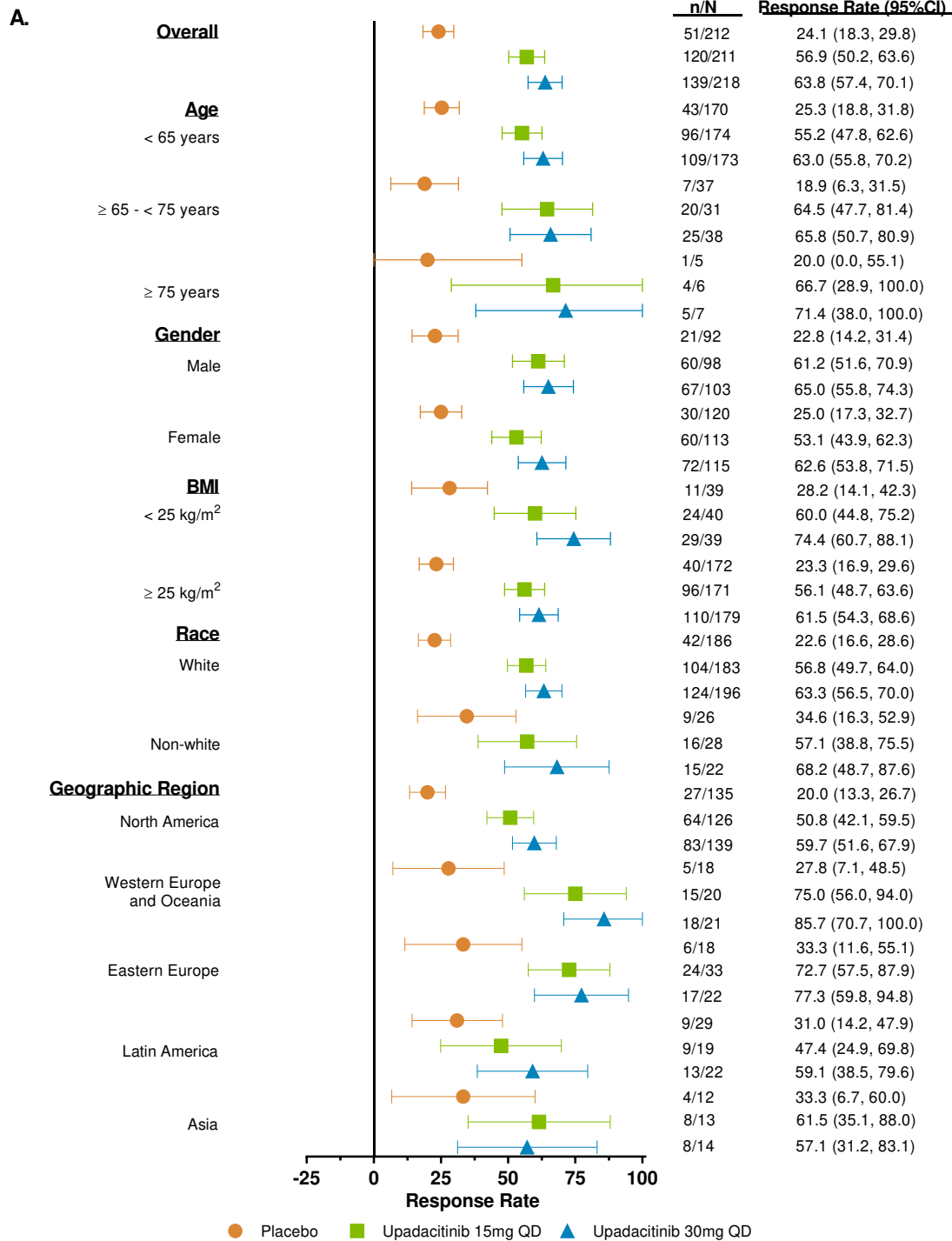

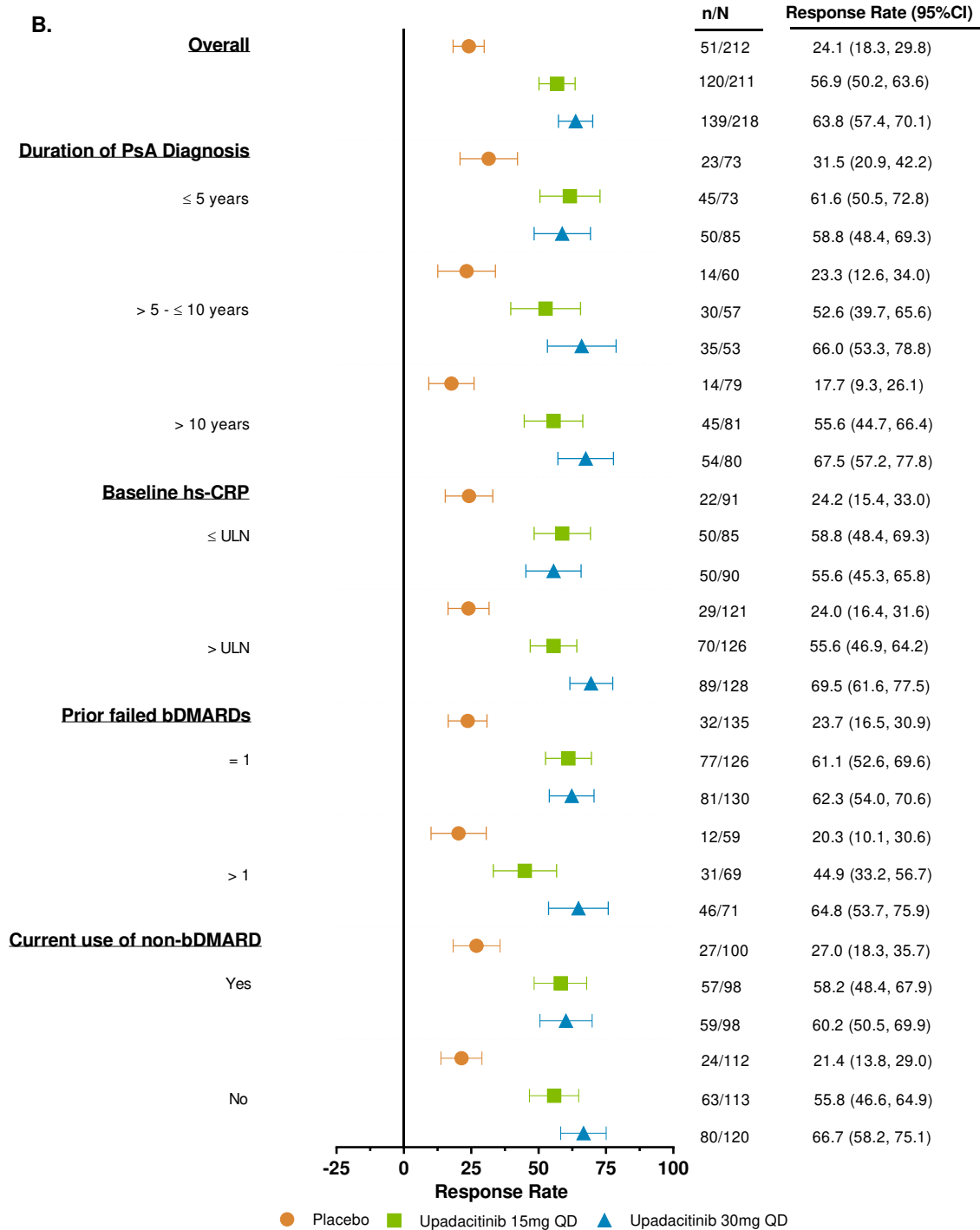

**Figure S5. Change from Baseline Over 24 Weeks in Core Components of the ACR Criteria (A)****TJC68 (B) SJC66 (C) PhGA (D) PtGA (E) Pain (F) hs-CRP**

\*,  $p \leq 0.05$ ; for upadacitinib 15mg QD versus placebo; #,  $p \leq 0.05$ ; for upadacitinib 30mg QD versus placebo

ACR, American College of Rheumatology; CI, confidence interval; hs-CRP, high-sensitivity C-reactive protein; NRS, numeric rating scale; PhGA, Physician's global assessment of disease activity; PtGA, patient's global assessment of disease activity; QD, once daily; SJC, swollen joint count; TJC, tender joint count; UPA; upadacitinib.

(C) The physician (Ph) and (D) patient (Pt) will rate the patient's current disease activity, taking into consideration both arthritis and psoriasis activity, independent of the subject's self-assessment, using a 0 - 10 NRS, anchored at either end by opposite adjectives. (E) Patients were asked to indicate their severity of pain within the previous week on a 0 to 10 NRS. A score of 0 indicates "no pain" and a score of 10 indicates "worst possible pain." [1]

Within group least square mean and 95% CI, and between group least square mean, 95% CI and nominal p-value were based on mixed-effect model repeated measurement (MMRM) analysis with unstructured variance-covariance matrix, including treatment, visit, treatment-by-visit interaction and prior biologic disease-modifying anti-rheumatic drugs use as fixed factors and baseline value as covariate.

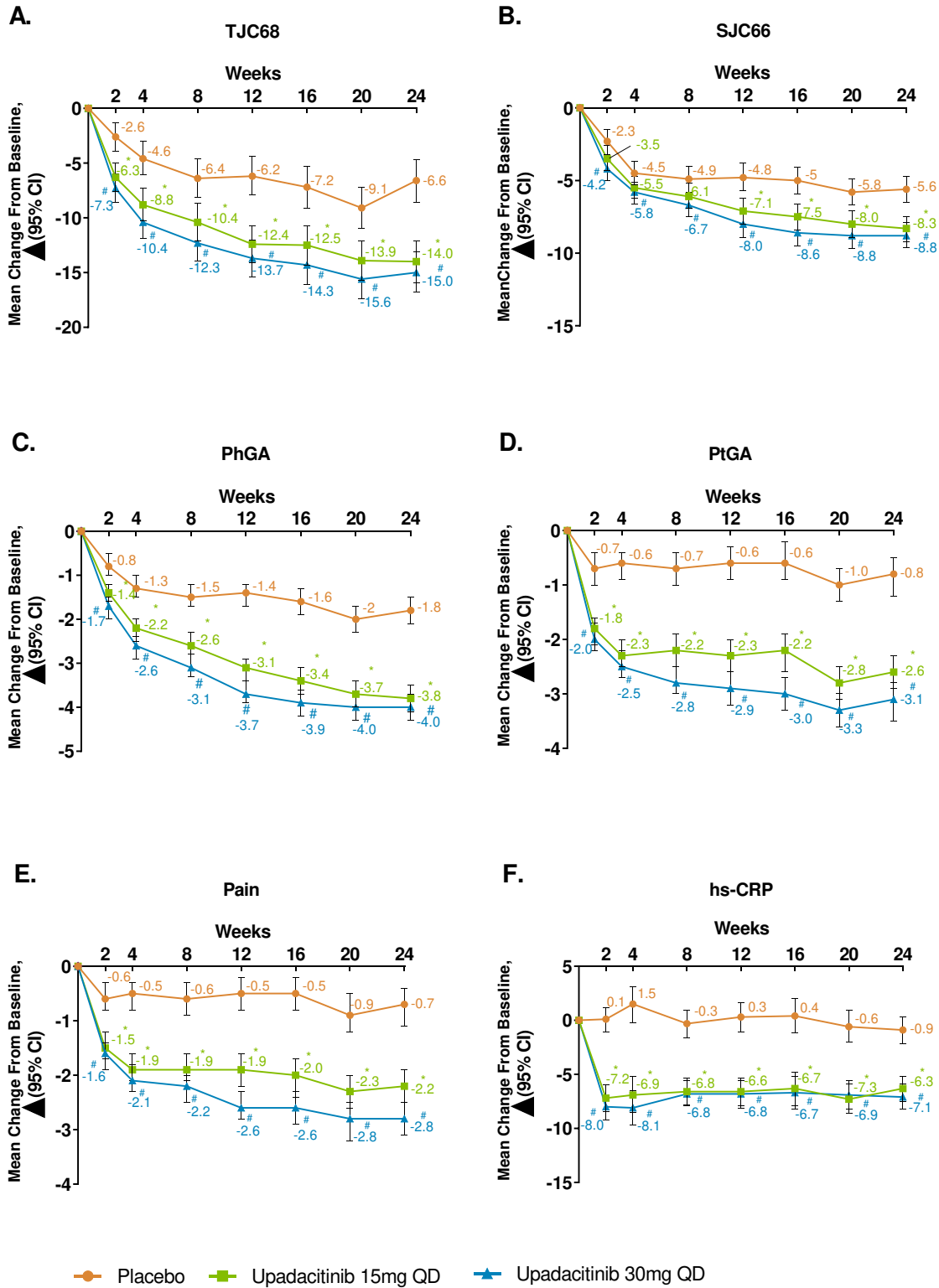

**Figure S6. Proportions of Patients Achieving sIGA 0/1 Over 24 Weeks**

\*,  $p \leq 0.05$ ; for upadacitinib 15mg QD versus placebo; #,  $p \leq 0.05$ ; for upadacitinib 30mg QD versus placebo; †, significant in the multiplicity-controlled analysis.

CI, confidence interval; QD, once daily; sIGA, Static Investigator Global Assessment.

After week 16 assessments have been performed patients may use concomitant treatments specifically for psoriasis per investigator judgment.

Results are based on non-responder imputation. 95% CIs for response rate were calculated based on normal approximation to the binominal distribution. 95% CIs for response rate difference were calculated based on normal approximation. Nominal p-value was constructed using Cochran-Mantel-Haenszel test adjusted for the main stratification factor of current disease-modifying anti-rheumatic drug use (yes/no).

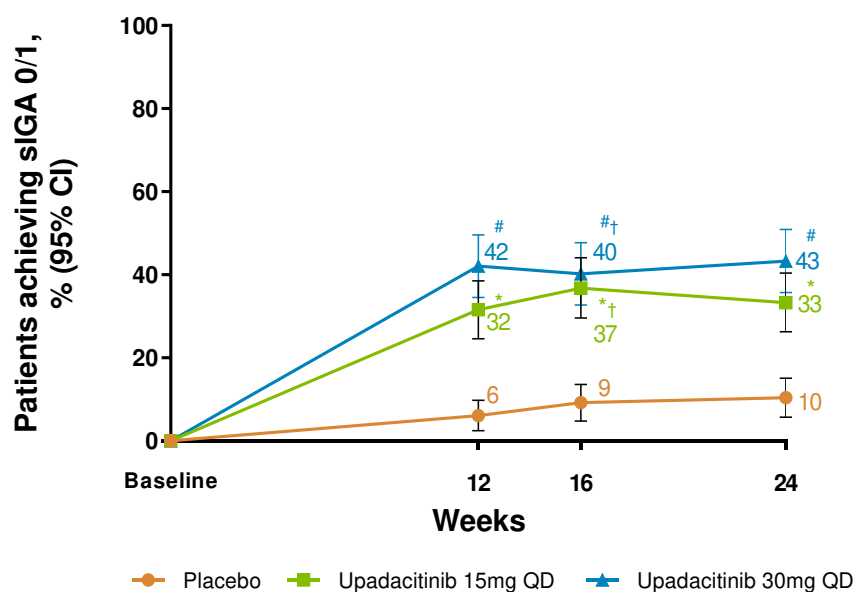
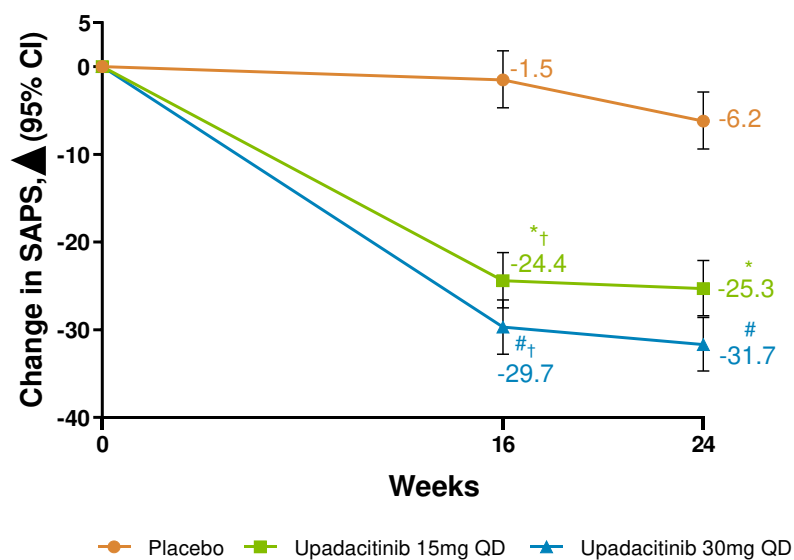

**Figure S7. Change from Baseline Over 24 Weeks in SAPS**

\*,  $p \leq 0.05$ ; for upadacitinib 15mg QD versus placebo; #,  $p \leq 0.05$ ; for upadacitinib 30mg QD versus placebo; †, significant in the multiplicity-controlled analysis.

CI, confidence interval; QD, once daily; SAPS, Self-Assessment of Psoriasis Symptoms.

Within group least square mean and 95% CI, and between group least square mean, 95% CI and nominal p-value are based on mixed-effect model repeated measurement (MMRM) analysis with unstructured variance-covariance matrix, including treatment, visit, treatment-by-visit interaction, the stratification factor current disease-modifying anti-rheumatic drug use (yes/no) as fixed factors and the continuous fixed covariate of baseline measurement.



**Figure S8. Change from Baseline Over 24 Weeks in (A) HAQ-DI and (B) SF-36 Physical****Component Summary**

\*,  $p \leq 0.05$ ; for upadacitinib 15mg QD versus placebo; #,  $p \leq 0.05$ ; for upadacitinib 30mg QD versus placebo; †, significant in the multiplicity-controlled analysis.

CI, confidence interval; HAQ-DI, Health assessment questionnaire disability index; PCS, physical component summary; QD, once daily; SF-36, Short Form Health Survey.

The PCS is one of two summary scores calculated from the eight SF-36 domains. A linear algorithm is applied to calculate the PCS which has normative mean value of 50, with higher scores indicating better outcomes.[2]

Within group least square mean and 95% CI, and between group least square mean, 95% CI and nominal p-value are based on mixed-effect model repeated measurement (MMRM) analysis with unstructured variance-covariance matrix, including treatment, visit, treatment-by-visit interaction, the stratification factor current disease-modifying anti-rheumatic drug use (yes/no) as fixed factors and the continuous fixed covariate of baseline measurement.

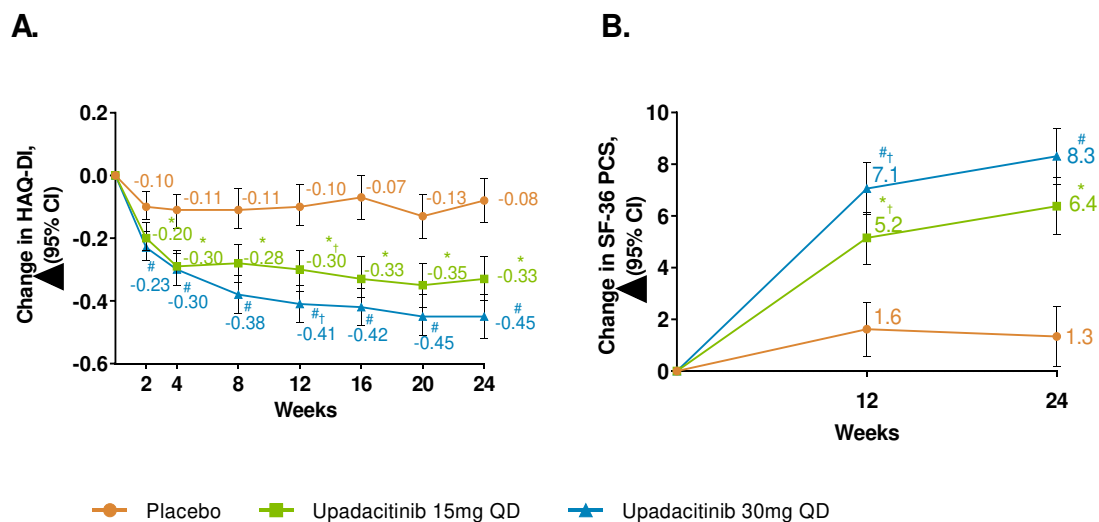

**Figure S9. Change from Baseline Over 24 Weeks in FACIT-F**

\*,  $p \leq 0.05$ ; for upadacitinib 15mg QD versus placebo; #,  $p \leq 0.05$ ; for upadacitinib 30mg QD versus placebo; †, significant in the multiplicity-controlled analysis.

CI, confidence interval; FACIT-F, Functional Assessment of Chronic Illness Therapy-Fatigue; QD, once daily.

The FACIT-F score ranges from 0-52, with higher scores indicating less fatigue.[3]

Within group least square mean and 95% CI, and between group least square mean, 95% CI and nominal p-value are based on Mixed-Effect Model Repeated Measurement (MMRM) analysis with unstructured variance-covariance matrix, including treatment, visit, treatment-by-visit interaction, the stratification factor current disease-modifying anti-rheumatic drug use (yes/no) as fixed factors and the continuous fixed covariate of baseline measurement. MMRM analysis uses observed longitudinal data up to week 12 prior to study drug premature discontinuation.

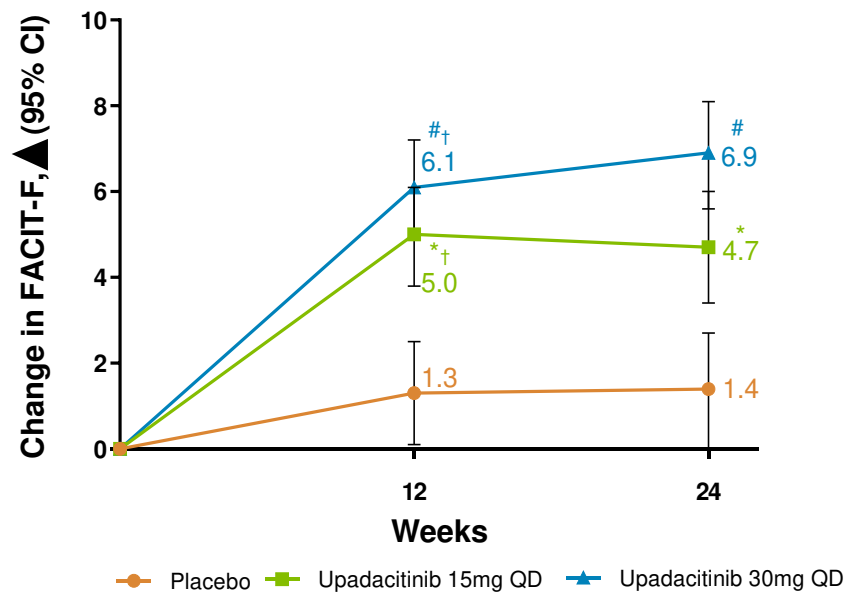

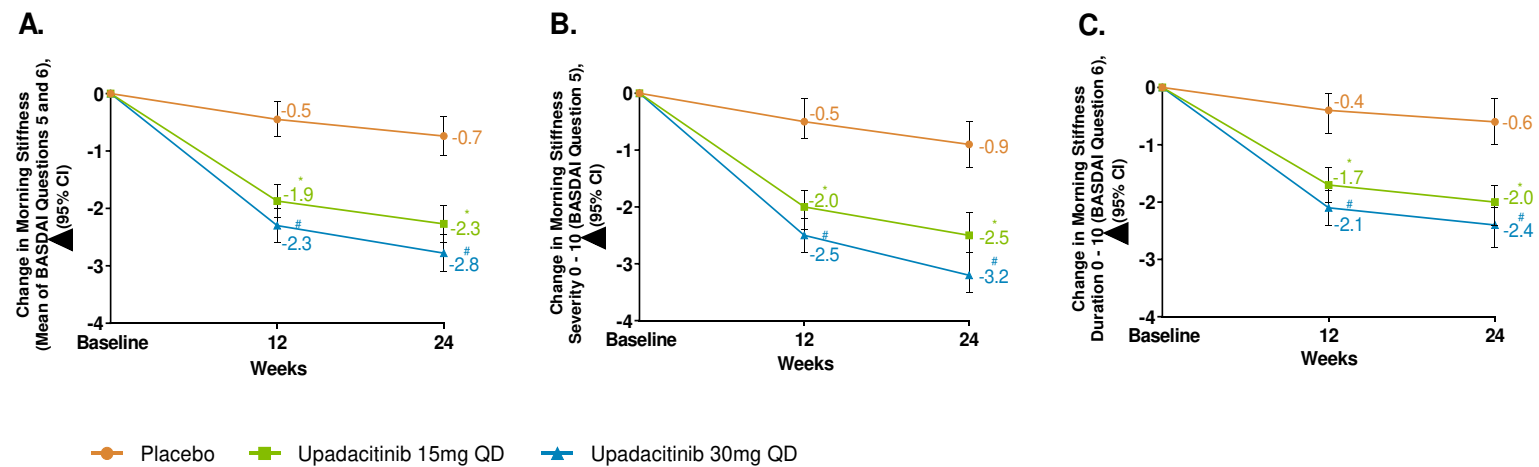

**Figure S10. (A) Change from Baseline Over 24 Weeks in Morning Stiffness (Mean of BASDAI Questions 5 and 6), (B), Morning Stiffness Severity (BASDAI Question 5), (C) Morning Stiffness Duration (BASDAI Question 6)**

\*,  $p \leq 0.05$ ; for upadacitinib 15mg QD versus placebo; #,  $p \leq 0.05$ ; for upadacitinib 30mg QD versus placebo.

BASDAI, Bath Ankylosing Spondylitis Disease Activity Index; CI, confidence interval; QD, once daily.

Within group least square mean and 95% CI, and between group least square mean, 95% CI and nominal p-value are based on Mixed-Effect Model Repeated Measurement (MMRM) analysis with unstructured variance-covariance matrix, including treatment, visit, treatment-by-visit interaction, the stratification factor current disease-modifying anti-rheumatic drug use (yes/no) as fixed factors and the continuous fixed covariate of baseline measurement.

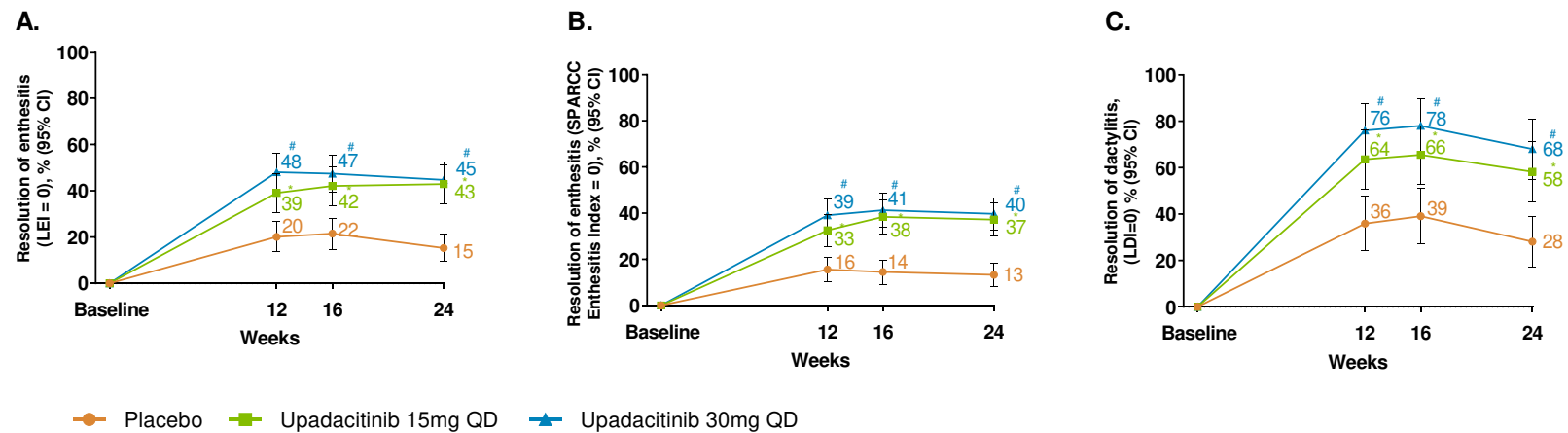

**Figure S11. Proportion of Patients with Resolution of Enthesitis Over 24 Weeks (A) by LEI and (B) by SPARCC; (C) Proportion of Patients with Resolution of Dactylitis by LDI**

\*,  $p \leq 0.05$ ; for upadacitinib 15mg QD versus placebo; #,  $p \leq 0.05$ ; for upadacitinib 30mg QD versus placebo.

CI, confidence interval; LDI, Leeds Dactylitis Index; LEI, Leeds Enthesitis Indices; QD, once daily; SPARCC, Spondyloarthritis Research Consortium of Canada.

Results are based on non-responder imputation with additional rescue handling, where patients rescued at week 16 are imputed as non-responders. 95% CIs for response rate were calculated based on normal approximation to the binominal distribution. 95% CIs for response rate difference were calculated based on normal approximation. Nominal p-value was constructed using Cochran-Mantel-Haenszel test adjusted for the main stratification factor of current disease-modifying anti-rheumatic drug use (yes/no).



**Figure S12. (A) Mean values from Baseline Over 24 Weeks (A) Hemoglobin (B) Platelets (C) Neutrophils (D) Lymphocytes**

QD, once daily.

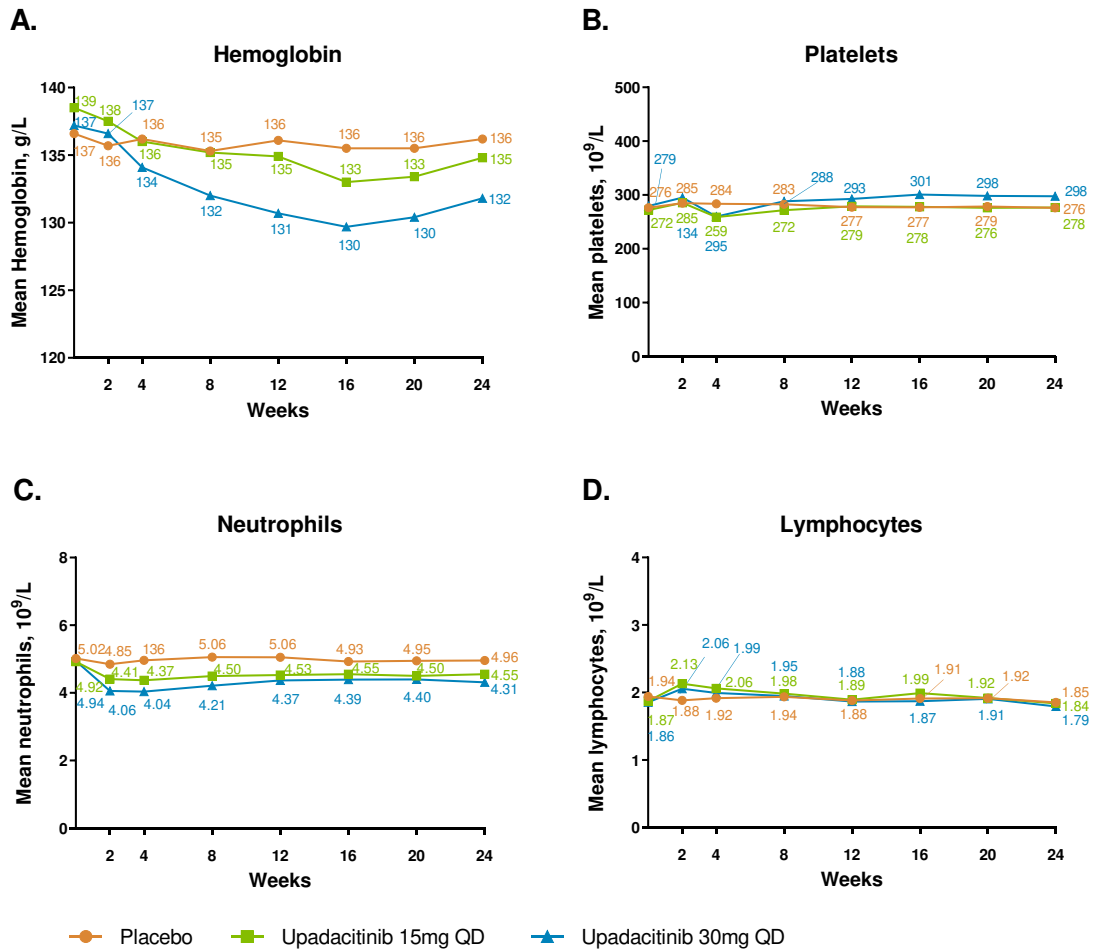

**Figure S13. Mean Values from Baseline Over 24 Weeks (A) LDL-C and (B) HDL-C; Mean ratio (C) LDL-C:HDL-C and (D) Total Cholesterol:HDL-C**

HDL-C, high-density lipoprotein cholesterol; LDL-C, low-density lipoprotein cholesterol; QD, once daily.

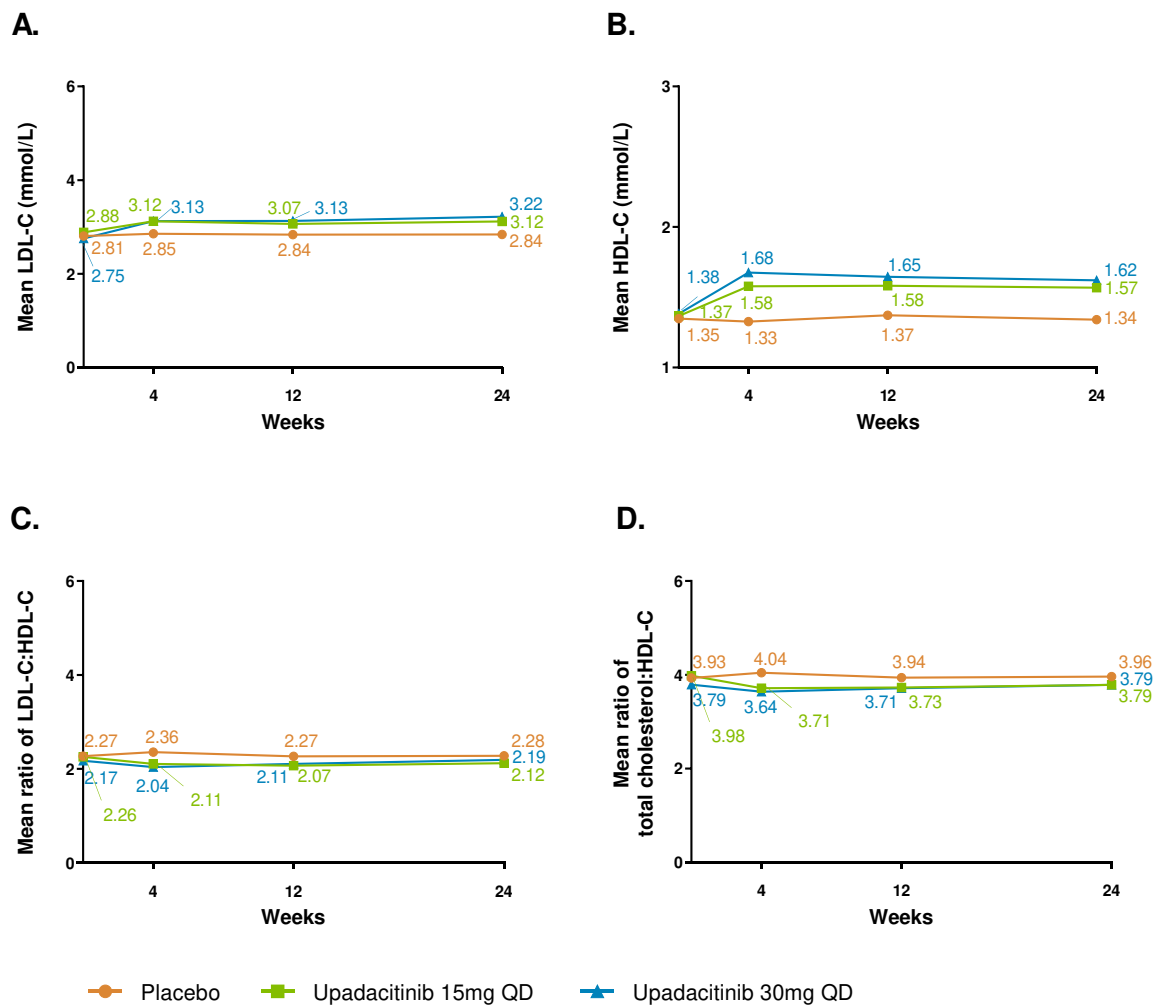

**Table S1. Description of Efficacy Measures**

Measure	Description
ACR20/50/70	Response rate determined based on 20%/50%/70% or greater improvement in TJC68 and SJC66 and $\geq 3$ of the 5 measures of Patient's Assessment of Pain (NRS), PtGA (NRS), PGA (NRS), HAQ-DI, or hs-CRP.
ASDAS	A composite disease activity measure for SpA, involving BASDAI (Question 2 [back pain], Question 3 [peripheral pain/swelling], Question 6 [duration of morning stiffness]), PtGA, and hs-CRP.
BASDAI	To measure and evaluate disease activity in SpA, using a 1-10 NRS for 6 questions pertaining to fatigue, spinal pain, joint pain/swelling, areas of localized tenderness/enthesitis, morning stiffness duration and severity.
FACIT-F	Measures physical fatigue (e.g., I feel tired), functional fatigue (e.g., trouble finishing things), emotional fatigue (e.g., frustration), and social consequences of fatigue (e.g., limits social activity). Responses are scored from 0 "not at all" to 4 "very much." The overall range is from 0 to 52 where higher scores indicate less fatigue.
HAQ-DI	Measures the degree of difficulty a person has in accomplishing tasks in 8 functional areas (dressing, arising, eating, walking, hygiene, reaching, gripping, and errands and chores) over the past week. Responses in each functional area are scored from 0, indicating no difficulty, to 3, indicating inability to perform a task in that area.
hs-CRP	Measures inflammation, where high levels of hs-CRP indicates increased inflammation.
LDI	To assess the presence or absence of dactylitis in all 20 of the subject's digits. Tenderness is assessed, as is circumference of dactylitic digits, measured with a dactylometer.
LEI	To assess the presence or absence of enthesitis at 3 bilateral sites. Tenderness on examination is recorded as either present, absent for an overall score range of 0 to 6.
MDA	Determined by fulfilling 5 of 7 outcome measures: TJC68 $\leq 1$ ; SJC66 $\leq 1$ ; PASI $\leq 1$ or BSA-Ps $\leq 3\%$ ; patient assessment of pain $\leq 1.5$ (0 – 10 NRS); PtGA-disease activity $\leq 2$ (0 – 10 NRS); HAQ-DI score $\leq 0.5$ ; and LEI $\leq 1$ .
Morning stiffness	Determined based on subject mean responses on BASDAI Questions 5 (severity of morning stiffness) and 6 (duration of morning stiffness).
PASI	Measures psoriasis severity at four anatomic sites – head, upper extremities, trunk, and lower extremities – are assessed for erythema, induration and desquamation using a 5-point scale.
SAPS	The SAPS is an 11-item self-assessment of psoriasis symptoms that includes questions on pain, itching, redness, scaling, flaking, bleeding, burning, stinging, tenderness, pain due to skin cracking, and joint pain.
SF-36 PCS	SF-36 is a validated instrument that assesses the general health-related quality of life of subjects and produces two summary scores. The PCS constitutes domains of physical functioning, role-physical,

	bodily pain, general health, and vitality. The score range for each domain is from 0 to 100, with higher scores indicating better health-related quality of life.
sIGA	5-point score ranging from 0 to 4, based on the investigator's assessment, at that time, of the average elevation, erythema, and scaling of all psoriatic lesions.
SJC66/TJC68	A total of 68 joints were scored for the presence or absence of tenderness (TJC) and 66 joints for presence or absence of swelling (SJC).
SPARCC Enthesitis Index	A total of 16 sites were assessed for the presence or absence of enthesitis.
ACR20/50/70, American College of Rheumatology 20%/50%/70% improvement criteria; ASDAS, ankylosing Spondylitis Disease Activity Score; BASDAI, Bath Ankylosing Spondylitis Disease Activity Index; CRP, C-reactive protein; FACIT-F, Functional Assessment of Chronic Illness Therapy-Fatigue; HAQ-DI, Health Assessment Questionnaire – Disability Index; hs-CRP, high-sensitivity C-reactive protein; LDI, Leeds Dactylitis Index; LEI, Leeds Enthesitis Indices; MDA, minimal disease activity; NRS, numerical rating scale; PASI, Psoriasis Area Severity Index; PGA, Physician's Global Assessment; PtGA, Patient's Global Assessment of Disease Activity; SAPS, Self-Assessment of Psoriasis Symptoms; SF-36 PCS, 36-Item Short Form Health Survey Physical Component Summary; sIGA, Static Investigator Global Assessment of Psoriasis; SJC, Swollen Joint Count; SPARCC, Spondyloarthritis Research Consortium of Canada; TJC, Tender Joint Count.	

<b>Table S2. Power of Key Secondary Endpoints</b>		
<b>Key Secondary Endpoints</b>	<b>Upadacitinib 15mg QD vs PBO</b>	<b>Upadacitinib 30mg QD vs PBO</b>
HAQ-DI at Week 12	98%	93%
sIGA at Week 16	99%	99%
PASI75 at Week 16	99%	99%
SF-36 PCS at Week 12	82%	82%
FACIT-F at Week 12	81%	81%
MDA at Week 24	<50%	<50%
SAPS at Week 16	99%	99%
ACR 50 at Week 12	89%	80%
ACR 70 at Week 12	75%	80%
ACR 20 at Week 2	85%	93%
ACR20, American College of Rheumatology 20% improvement criteria; FACIT-F, Functional Assessment of Chronic Illness Therapy-Fatigue; HAQ-DI, Health Assessment Questionnaire – Disability Index; MDA, minimal disease activity; PASI, Psoriasis Area Severity Index; SAPS, Self-Assessment of Psoriasis Symptoms; SF-36 PCS, 36-Item Short Form Health Survey Physical Component Summary; sIGA, Static Investigator Global Assessment of Psoriasis; QD, once daily.		

<b>Table S3. Patients with Treatment-Emergent Adverse Events Reported in <math>\geq 5\%</math> of Patients in any Treatment Arm up to Week 24 (Safety Analysis Set)</b>			
<b>MedDRA Preferred Term, n/N (%)</b>	<b>Placebo, N = 212</b>	<b>Upadacitinib 15mg QD, N=211</b>	<b>Upadacitinib 30mg QD, N=218</b>
Upper respiratory tract infection	10 (4.7)	13 (6.2)	23 (10.6)
Nasopharyngitis	17 (8.0)	10 (4.7)	20 (9.2)
Bronchitis	5 (2.4)	10 (4.7)	12 (5.5)
Psoriatic arthropathy	11 (5.2)	10 (4.7)	3 (1.4)
Urinary tract infection	12 (5.7)	9 (4.3)	11 (5.0)
Influenza	3 (1.4)	8 (3.8)	11 (5.0)
Diarrhoea	12 (5.7)	5 (2.4)	12 (5.5)
Nausea	7 (3.3)	4 (1.9)	11 (5.0)
Blood creatine phosphokinase increased	4 (1.9)	4 (1.9)	12 (5.5)
MedDRA, Medical Dictionary for Regulatory Activities; QD, once daily			



<b>Table S4. Patients Meeting Criteria for Potentially Clinically Significant Values for Laboratory Variables up to Week 24</b>				
<b>Parameter, n/N (%)</b>		<b>Placebo, N = 212</b>	<b>Upadacitinib 15mg QD, N=211</b>	<b>Upadacitinib 30mg QD, N=218</b>
Hemoglobin (g/L)	Grade 3	0	0	2/217 (0.9)
	Grade ≥3 (<80)	0	0	2/217 (0.9)
Platelets (x10 <sup>9</sup> /L)	Grade 3 (25 -<50)	0	0	0
	Grade 4 (<25)	0	0	0
Lymphocytes (x10 <sup>9</sup> /L)	Grade 3 (0.2 - <0.5)	0	1/210 (0.5)	2/217 (0.9)
	Grade 4 (< 0.2)	0	0	0
Neutrophils (x10 <sup>9</sup> /L)	Grade 3 (0.5 - <1.0)	1/207 (0.5)	2/210 (1.0)	4/217 (1.8)
	Grade 4 (< 0.5)	0	0	0
ALT (U/L)	Grade 3 (>5.0 - 20.0 x ULN)	1/207 (0.5)	2/210 (1.0)	1/217 (0.5)
	Grade 4 (> 20.0 x ULN)	0	0	0
AST (U/L)	Grade 3 (>5.0 - 20.0 x ULN)	1/207 (0.5)	2/210 (1.0)	0
	Grade 4 (> 20.0 x ULN)	0	0	0
CPK (U/L)	Grade 3 (>5.0 - 10.0 x ULN)	1/207 (0.5)	1/210 (0.5)	5/217 (2.3)
	Grade 4 (>10.0 x ULN)	2/207 (1.0)	1/210 (0.5)	0
Creatinine (μMoL/L)	Grade 3 (>3.0 - 6.0 x ULN)	0	0	1/217 (0.5)
	Grade 4 (>6.0 x ULN)	0	0	0
ALT, alanine aminotransferase; AST, aspartate aminotransferase; CPK, creatine phosphokinase				

<b>Table S5. Shift Analysis for the Lipids from Within Normal Limit to Upper Limit Normal</b>			
<b>Parameter</b>	<b>Placebo, N = 212</b>	<b>Upadacitinib 15mg QD, N=211</b>	<b>Upadacitinib 30mg QD, N=218</b>
Cholesterol (mmol/l), n/N WNL (%) Change from baseline to post-baseline, Mean ± SD	3/141 (2.1) 1.54 ± 0.56	24/149 (16.1) 2.29 ± 2.78	22/132 (16.7) 2.37 ± 0.79
HDL cholesterol (mmol/l), n/N WNL (%) Change from baseline to post-baseline, Mean ± SD	7/184 (3.8) 0.62 ± 0.50	35/186 (18.8) 0.50 ± 0.23	43/191 (22.5) 0.67 ± 0.30
LDL cholesterol (mmol/l), n/N WNL (%) Change from baseline to post-baseline, Mean ± SD	3/151 (2.0) 1.54 ± 0.97	12/151 (7.9) 1.41 ± 0.62	11/148 (7.4) 2.12 ± 1.47
Triglycerides (mmol/l), n/N WNL (%) Change from baseline to post-baseline, Mean ± SD	20/193 (10.4) 1.52 ± 1.16	20/179 (11.2) 2.03 ± 1.12	32/196 (16.3) 2.15 ± 1.62
HDL, high-density lipoprotein; LDL, low-density lipoprotein; QD, once daily; SD, standard deviation; ULN, upper limit normal; WNL, within normal limit. n is defined as the number of patients who shifted to >ULN by Week 24 (using worst post-baseline value). N WNL is defined as the number of patients who were within normal limit (≤ULN and ≥LLN) at baseline.			

**References**

1. McCormack HM, Horne DJ, Sheather S. Clinical applications of visual analogue scales: a critical review. *Psychol Med* 1988;18: 1007–19.
2. Ware JE, Kosinski M, Dewey JE. How to score version two of the SF-36 health survey. Lincoln, RI: Quality Metric, 2000.
3. Yellen SB, Cella DF, Webster K, et al. Measuring fatigue and other anemia-related symptoms with the Functional Assessment of Cancer Therapy (FACT) Measurement System. *J Pain Symptom Manage* 1997;13:63-74.